

Article number: 03446020

Description: Fluro Heavy Duty Spherical Plain Bearing GE 20 GW-2RS
Hole Ø20

Note: 20

Measures

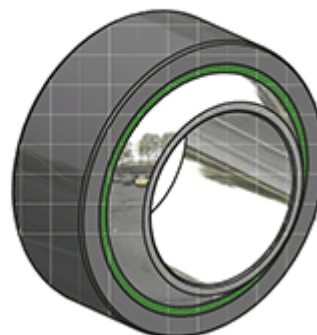
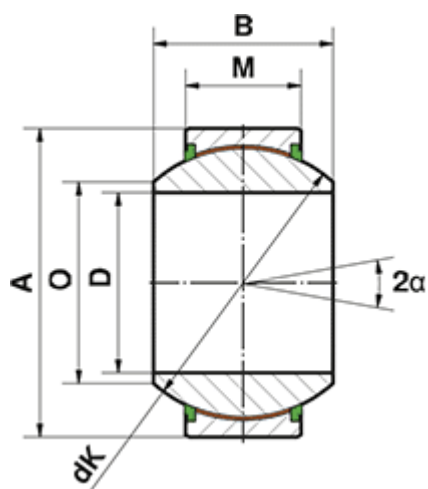

	= -	Dynamic load C (kN) = 110
	= -	M = 16
	= -	O = 25.2
A	= 42	Static load C0 (kN) = 182
a (degrees)	= 17	Weight (g) = 153
B	= 25	
D	= 20	
dK	= 35.5	